

**P-Channel Enhancement Mode Power MOSFET**

# MTEF1P15AV8

BV <sub>DSS</sub>	-150V
I <sub>D</sub>	-5.4A @ V <sub>GS</sub> =-10V, T <sub>C</sub> =25°C
R <sub>DSON(Typ)</sub>	0.52 Ω @ V <sub>GS</sub> =-10V, I <sub>D</sub> =-1.4A
	0.56 Ω @ V <sub>GS</sub> =-6V, I <sub>D</sub> =-1A

**Features**

- Simple drive requirement
- Low on-resistance
- Fast switching speed
- Pb-free lead plating and halogen-free package

**Equivalent Circuit**

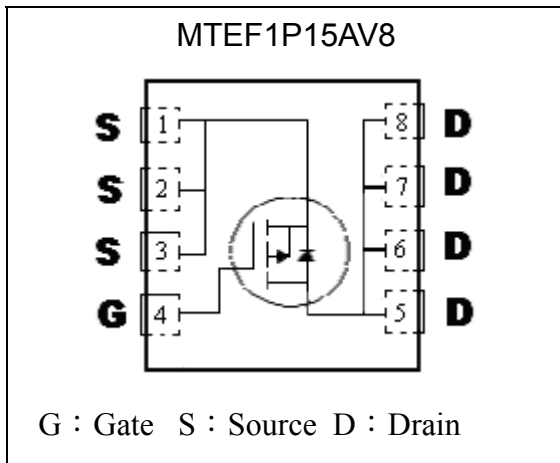

**Outline**

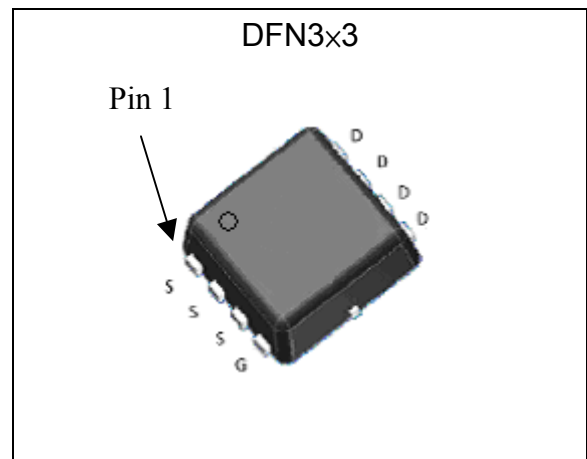

**Ordering Information**

Device	Package	Shipping
MTEF1P15AV8-0-T6-G	DFN3x3 (Pb-free lead plating and halogen-free package)	3000 pcs / tape & reel

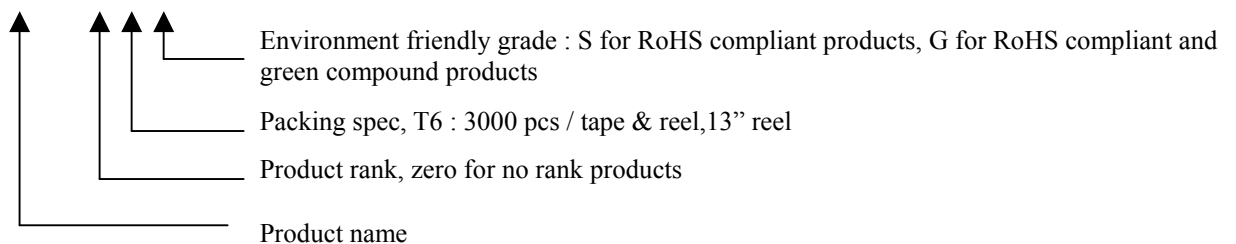



**Absolute Maximum Ratings** (T<sub>C</sub>=25°C, unless otherwise noted)

Parameter	Symbol	Limits	Unit
Drain-Source Voltage	V <sub>DS</sub>	-150	V
Gate-Source Voltage	V <sub>GS</sub>	±30	
Continuous Drain Current @ T <sub>C</sub> =25°C, V <sub>GS</sub> =-10V	I <sub>D</sub>	-5.4	A
Continuous Drain Current @ T <sub>C</sub> =100°C, V <sub>GS</sub> =-10V		-3.4	
Continuous Drain Current @ T <sub>A</sub> =25°C, V <sub>GS</sub> =-10V *3		-1.3	
Continuous Drain Current @ T <sub>A</sub> =70°C, V <sub>GS</sub> =-10V *3		-1.0	
Pulsed Drain Current *1, 2		I <sub>DM</sub>	
Continuous Source-Drain Diode Current T <sub>C</sub> =25°C	I <sub>S</sub>	-5.4	
Avalanche Current	I <sub>AS</sub>	-10	
Avalanche Energy @ L=1mH, I <sub>D</sub> =-10A, V <sub>GS</sub> =-10V *4	E <sub>AS</sub>	50	mJ
Maximum Power Dissipation	P <sub>D</sub>	T <sub>C</sub> =25°C	W
		T <sub>C</sub> =70°C	
		T <sub>A</sub> =25°C *3	
		T <sub>A</sub> =70°C *3	
Operating Junction and Storage Temperature Range	T <sub>j</sub> , T <sub>stg</sub>	-55~+150	°C

**Thermal Data**

Parameter	Symbol	Typ	Maximum	Unit
Thermal Resistance, Junction-to-ambient *3	R <sub>th,j-a</sub>	50	60	°C/W
Thermal Resistance, Junction-to-case	R <sub>th,j-c</sub>	2.5	3	

- Note :
1. Pulse width limited by maximum junction temperature.
  2. Duty cycle ≤ 1%.
  3. Surface mounted on 1 in<sup>2</sup> copper pad of FR-4 board; 135°C/W when mounted on minimum pad of 2 oz. copper.
  4. 100% tested by conditions of L=1mH, V<sub>GS</sub>=-10V, I<sub>AS</sub>=-7A, V<sub>DD</sub>=-25V

**Characteristics (T<sub>C</sub>=25°C, unless otherwise specified)**

Symbol	Min.	Typ.	Max.	Unit	Test Conditions
<b>Static</b>					
BV <sub>DSS</sub>	-150	-	-	V	V <sub>GS</sub> =0V, I <sub>D</sub> =-250μA
ΔBV <sub>DSS</sub> /ΔT <sub>J</sub>	-	-106	-	mV/°C	I <sub>D</sub> =-250μA
ΔV <sub>GS(th)</sub> /ΔT <sub>J</sub>	-	6	-		
V <sub>GS(th)</sub>	-2	-	-4	V	V <sub>DS</sub> =V <sub>GS</sub> , I <sub>D</sub> =-250μA
I <sub>GSS</sub>	-	-	±100	nA	V <sub>GS</sub> =±30V, V <sub>DS</sub> =0V
I <sub>DSS</sub>	-	-	-1	μA	V <sub>DS</sub> =-120V, V <sub>GS</sub> =0V
	-	-	-10		V <sub>DS</sub> =-120V, V <sub>GS</sub> =0V, T <sub>J</sub> =55°C
R <sub>DS(ON)</sub> *1	-	0.52	0.68	Ω	V <sub>GS</sub> =-10V, I <sub>D</sub> =-1.4A
	-	0.56	0.79		V <sub>GS</sub> =-6V, I <sub>D</sub> =-1A
G <sub>FS</sub> *1	-	2.8	-	S	V <sub>DS</sub> =-10V, I <sub>D</sub> =-1.4A

<b>Dynamic</b>					
Qg *1,2	-	10.5	-	nC	V <sub>DS</sub> =-75V, I <sub>D</sub> =-5.4A, V <sub>GS</sub> =-10V
Qgs *1,2	-	3.1	-		
Qgd *1,2	-	2.9	-		
t <sub>d(ON)</sub> *1,2	-	9.8	-	ns	V <sub>DS</sub> =-75V, I <sub>D</sub> =-1A, V <sub>GS</sub> =-10V, R <sub>G</sub> =6Ω
t <sub>r</sub> *1,2	-	16.6	-		
t <sub>d(OFF)</sub> *1,2	-	31.4	-		
t <sub>f</sub> *1,2	-	28.4	-		
C <sub>iss</sub>	-	571	-	pF	V <sub>DS</sub> =-30V, V <sub>GS</sub> =0V, f=1MHz
C <sub>oss</sub>	-	29	-		
C <sub>rss</sub>	-	17	-		
<b>Source-Drain Diode</b>					
I <sub>S</sub> *1	-	-	-5.4	A	T <sub>C</sub> =25°C
I <sub>SM</sub> *3	-	-	-16		
V <sub>SD</sub> *1	-	-0.77	-1.2	V	I <sub>F</sub> =-1A, V <sub>GS</sub> =0V
t <sub>rr</sub>	-	28	-	ns	I <sub>F</sub> =-1A, dI <sub>F</sub> /dt=100A/μs
Q <sub>rr</sub>	-	33	-	nC	

Note : \*1.Pulse Test : Pulse Width ≤300μs, Duty Cycle≤2%  
 \*2.Independent of operating temperature  
 \*3.Pulse width limited by maximum junction temperature.

### Recommended Soldering Footprint

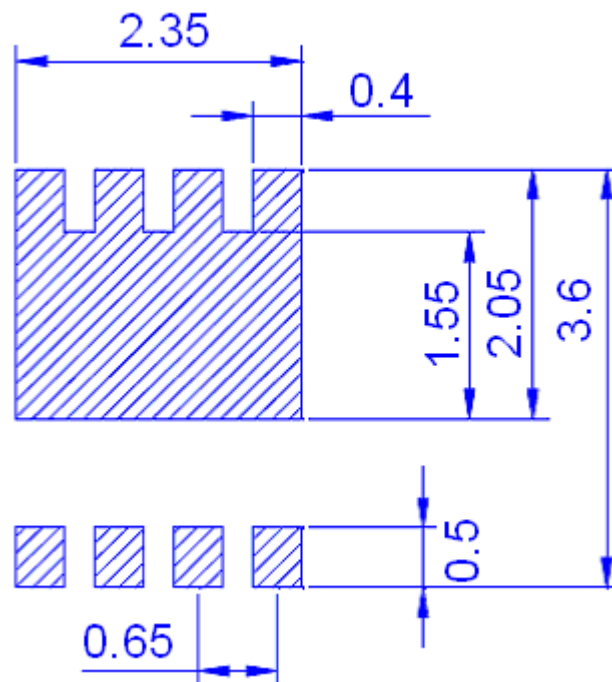

unit : mm

**Typical Characteristics**

Typical Output Characteristics

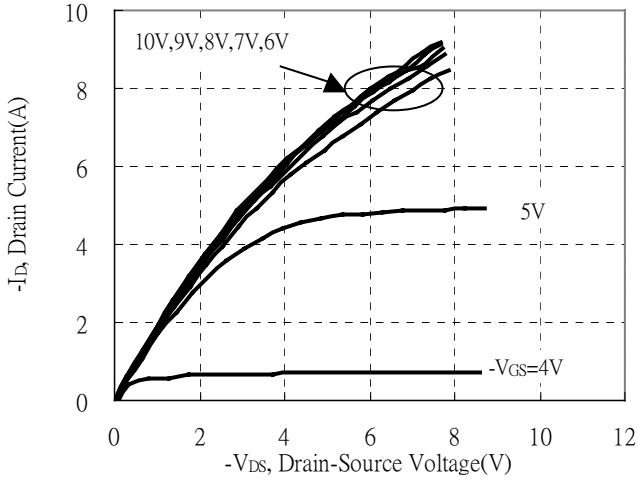

Brekdown Voltage vs Ambient Temperature

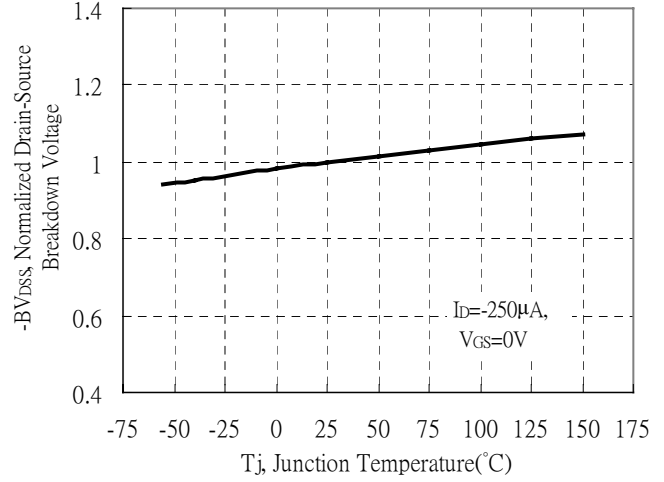

Static Drain-Source On-State resistance vs Drain Current

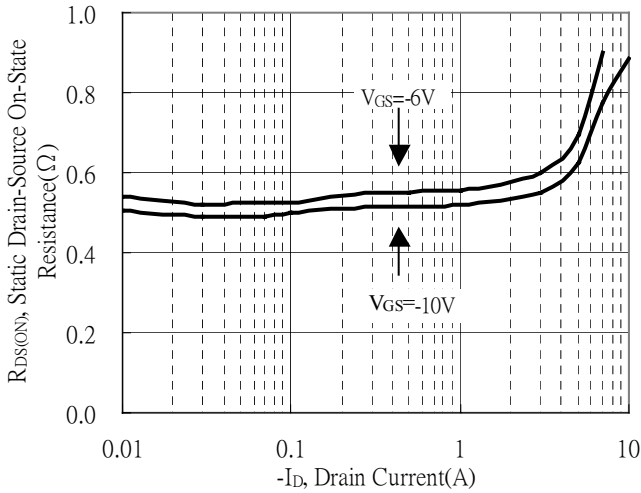

Reverse Drain Current vs Source-Drain Voltage

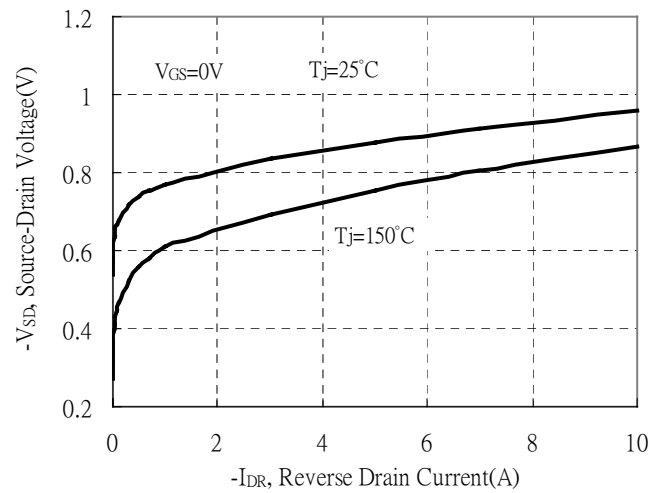

Static Drain-Source On-State Resistance vs Gate-Source Voltage

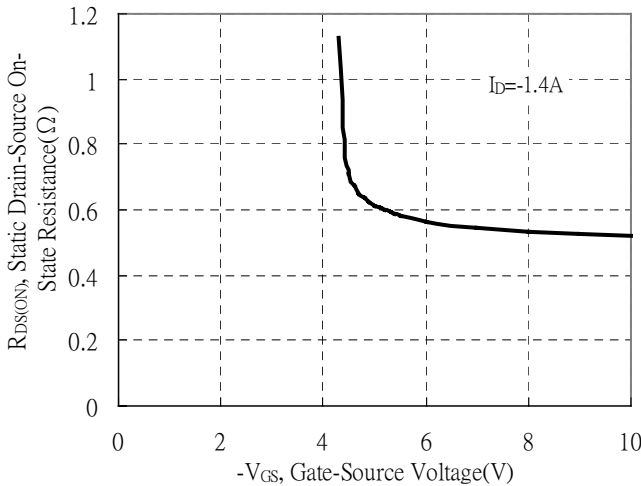

Drain-Source On-State Resistance vs Junction Temperature

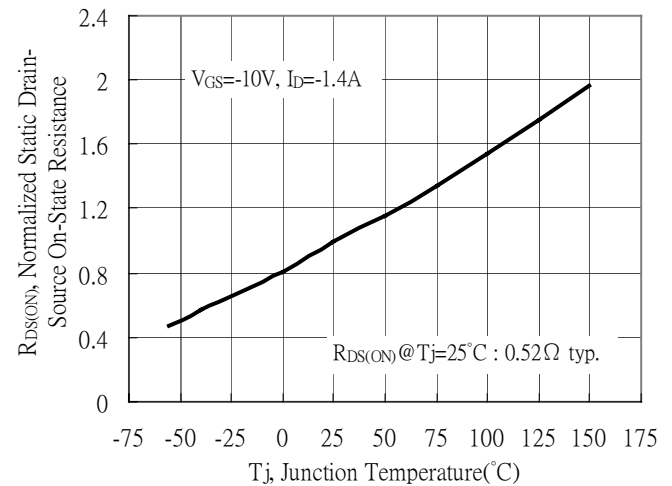

## Typical Characteristics(Cont.)

Capacitance vs Drain-to-Source Voltage

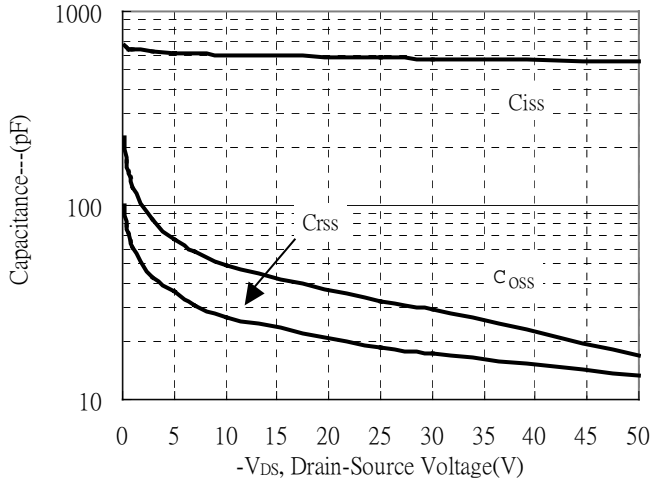

Threshold Voltage vs Junction Temperature

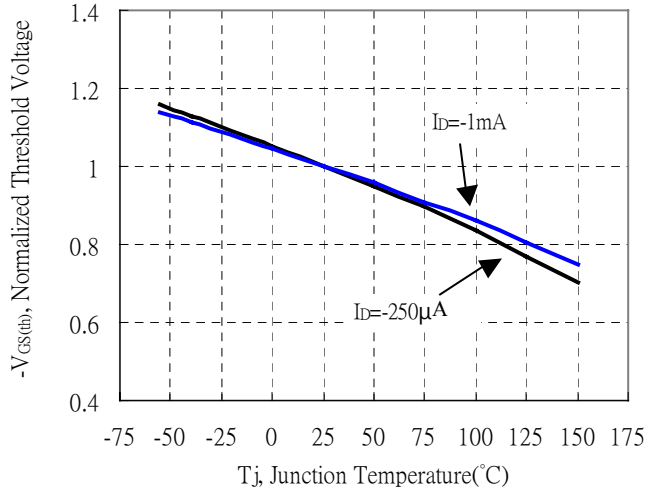

Maximum Safe Operating Area

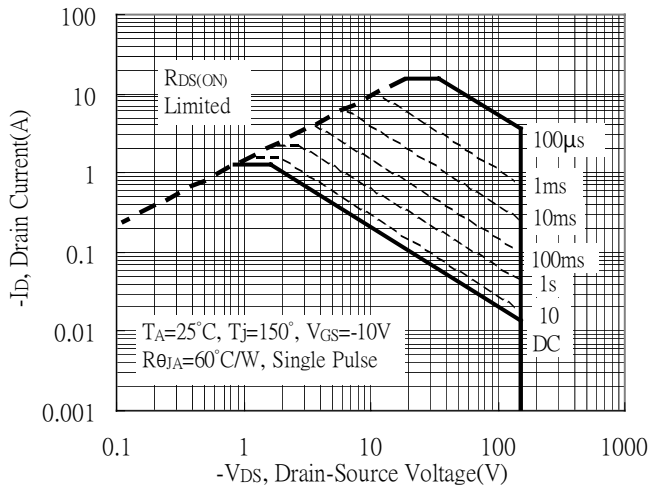

Gate Charge Characteristics

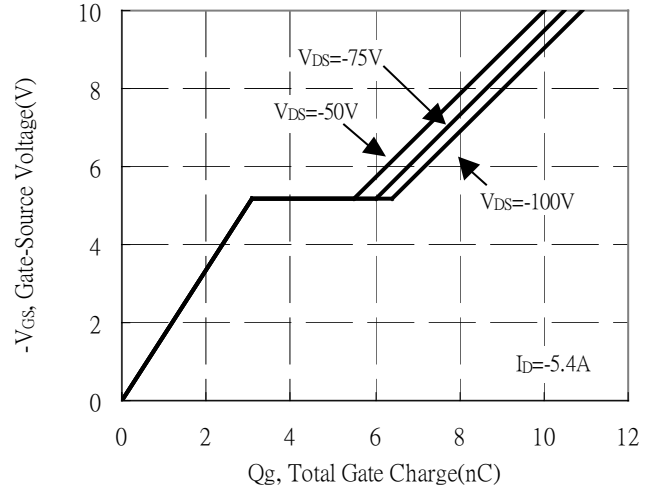

Forward Transfer Admittance vs Drain Current

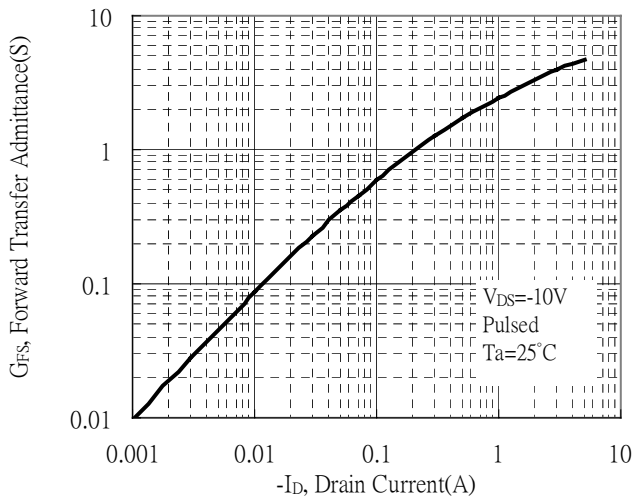

Maximum Drain Current vs Junction Temperature

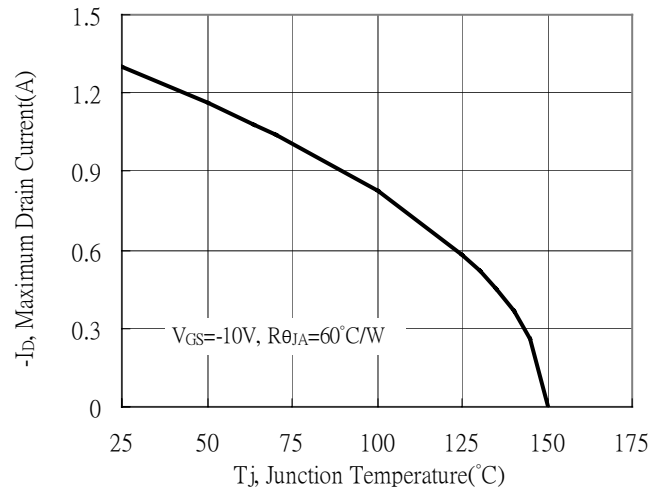

**Typical Characteristics(Cont.)**

Typical Transfer Characteristics

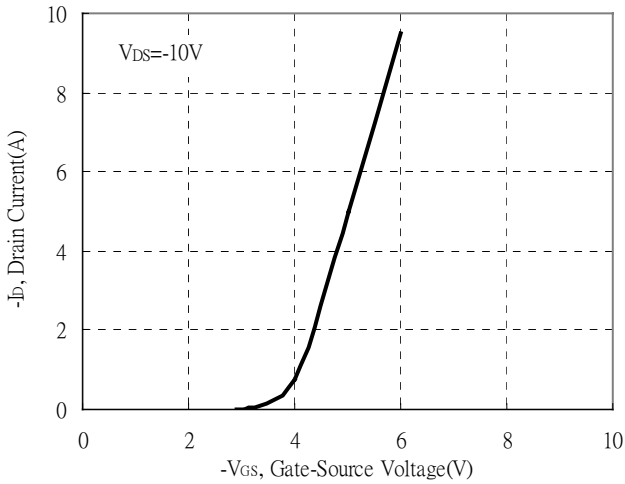

Single Pulse Maximum Power Dissipation

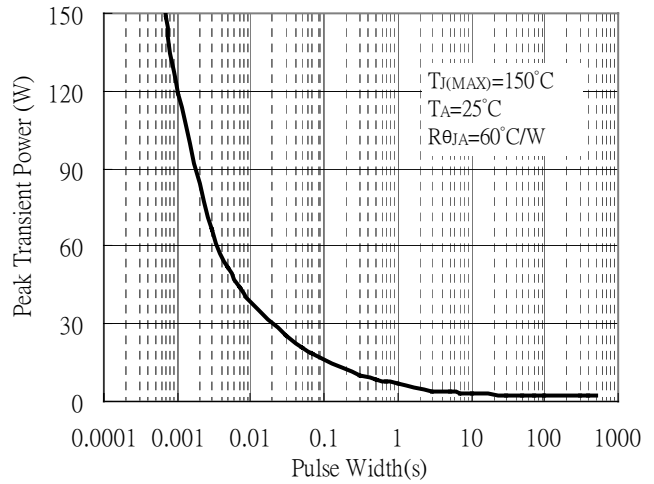

Transient Thermal Response Curves

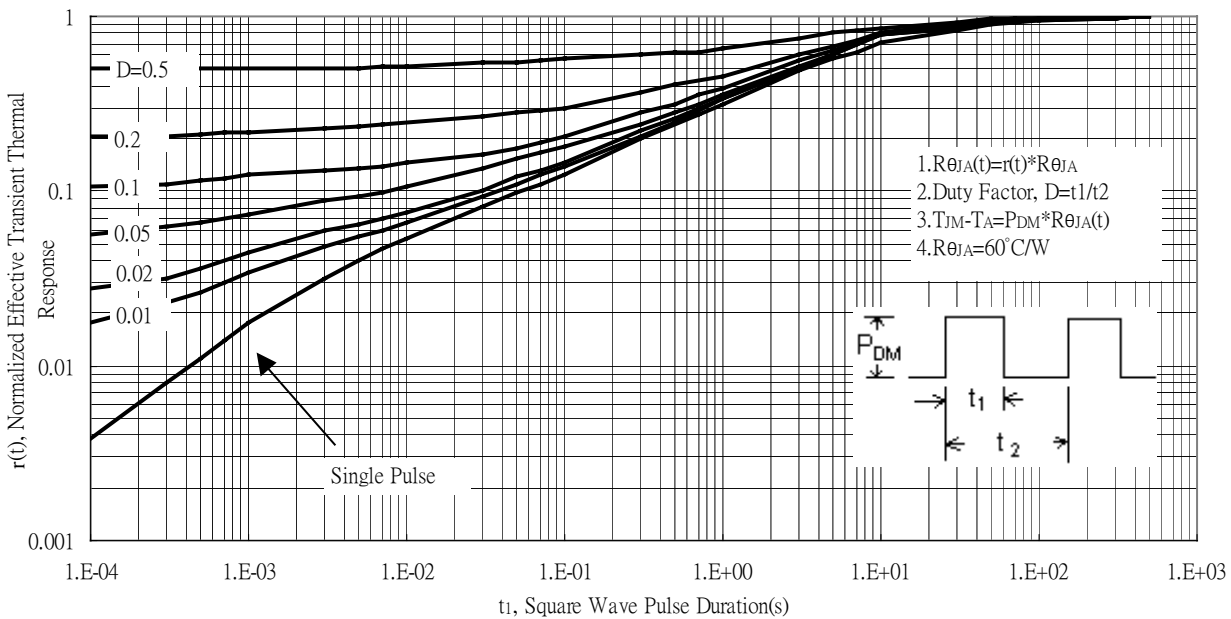

**Reel Dimension**

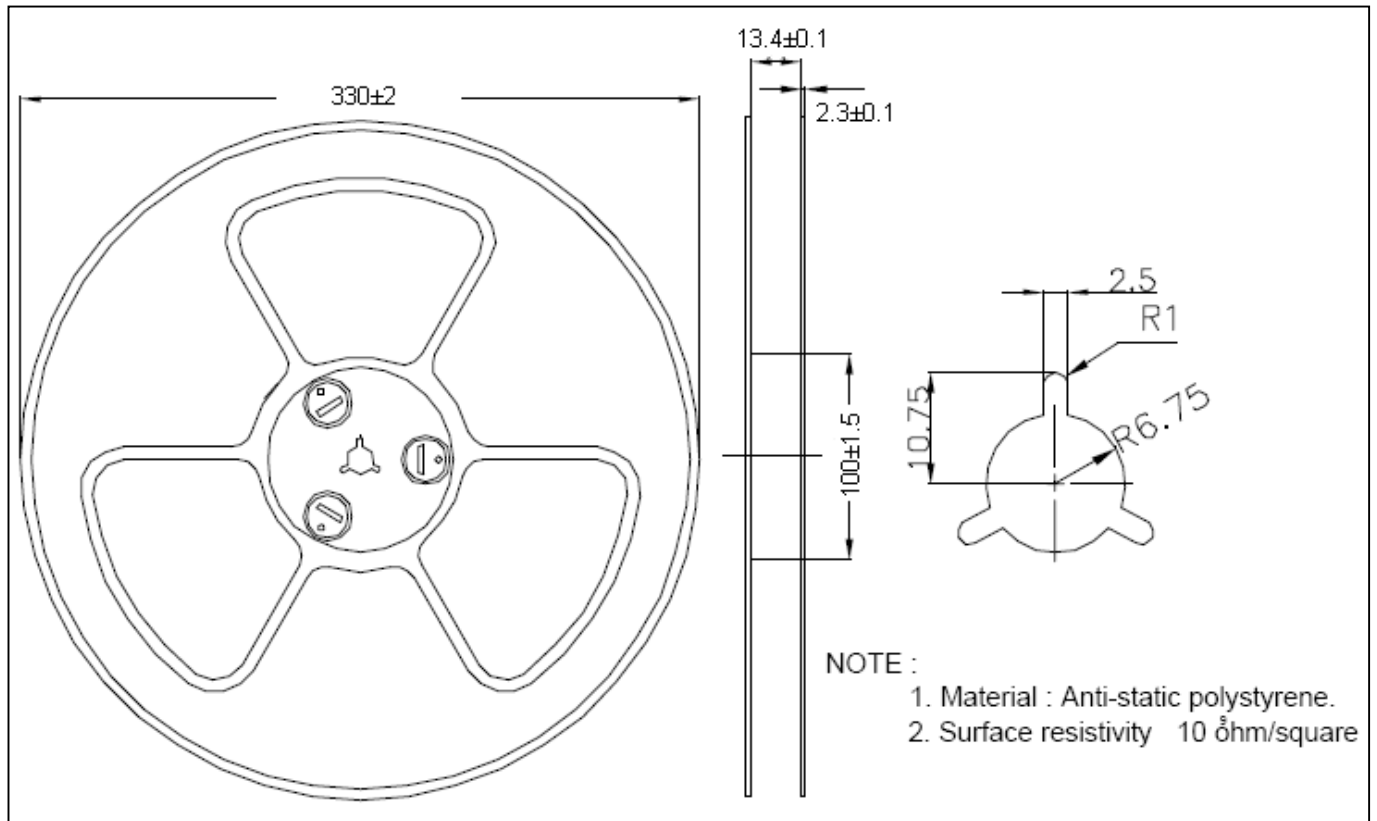

**Carrier Tape Dimension**

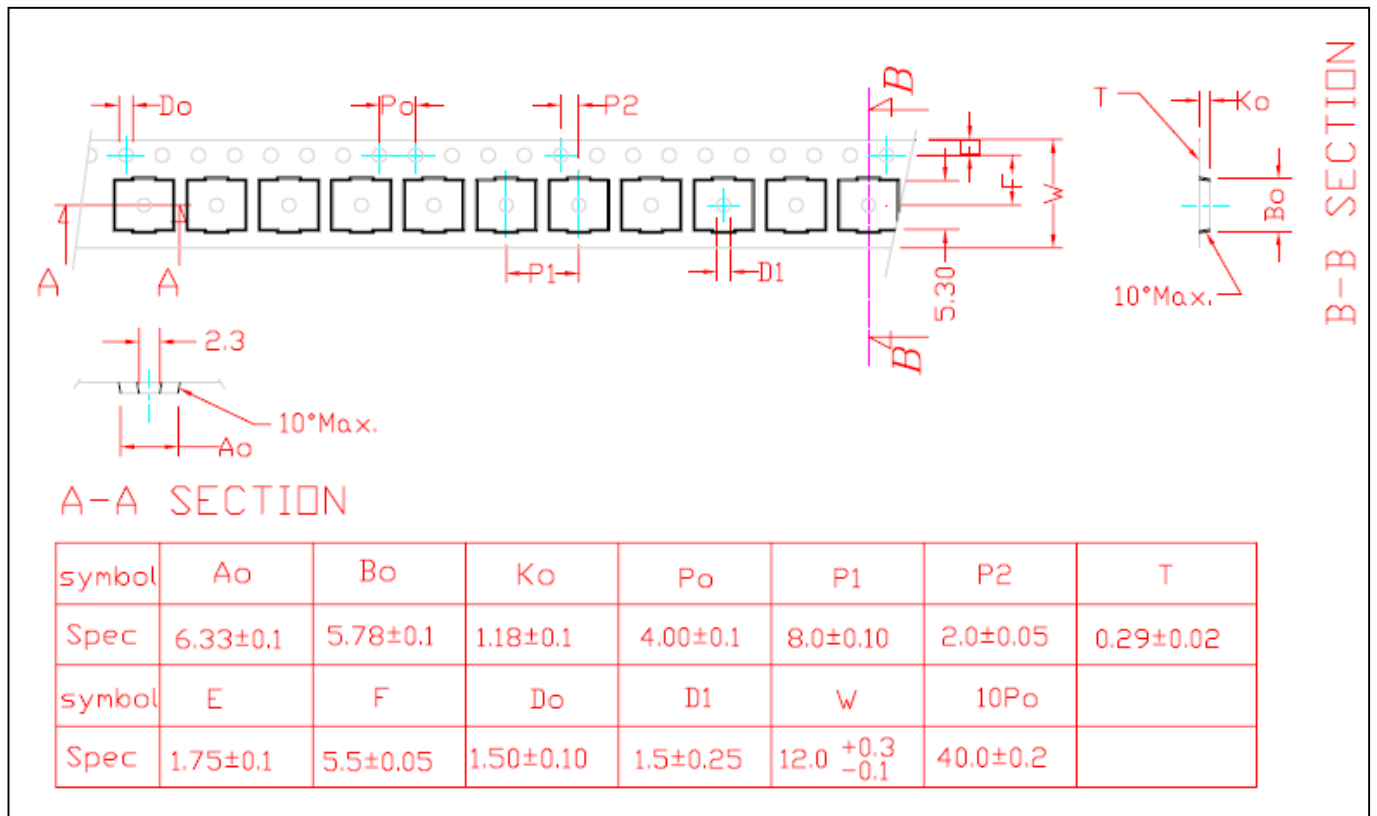

**Recommended wave soldering condition**

Product	Peak Temperature	Soldering Time
Pb-free devices	260 +0/-5 °C	5 +1/-1 seconds

**Recommended temperature profile for IR reflow**

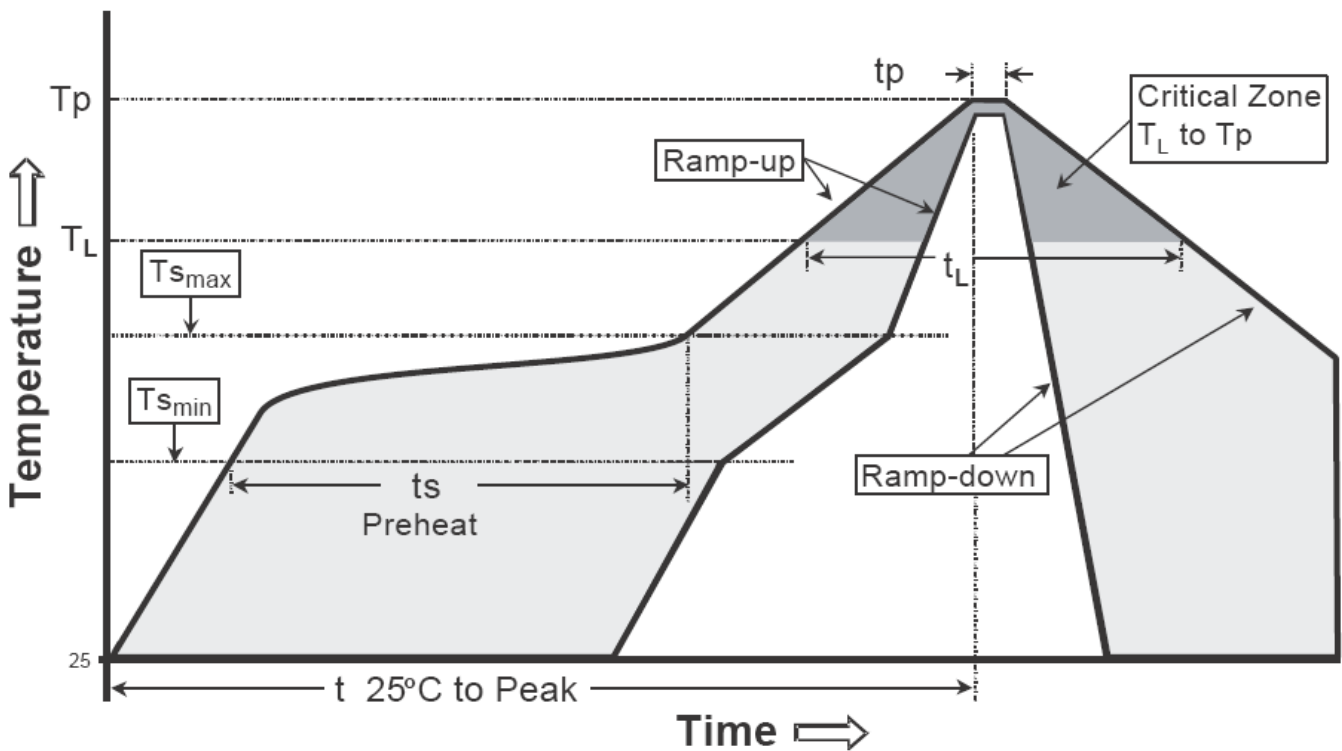

Profile feature	Sn-Pb eutectic Assembly	Pb-free Assembly
Average ramp-up rate (Tsmmax to Tp)	3°C/second max.	3°C/second max.
Preheat		
-Temperature Min(Ts min)	100°C	150°C
-Temperature Max(Ts max)	150°C	200°C
-Time(ts min to ts max)	60-120 seconds	60-180 seconds
Time maintained above:		
-Temperature (Tl)	183°C	217°C
- Time (tl)	60-150 seconds	60-150 seconds
Peak Temperature(Tp)	240 +0/-5 °C	260 +0/-5 °C
Time within 5°C of actual peak temperature(tp)	10-30 seconds	20-40 seconds
Ramp down rate	6°C/second max.	6°C/second max.
Time 25 °C to peak temperature	6 minutes max.	8 minutes max.

Note : All temperatures refer to topside of the package, measured on the package body surface.



**DFN3x3 Dimension**

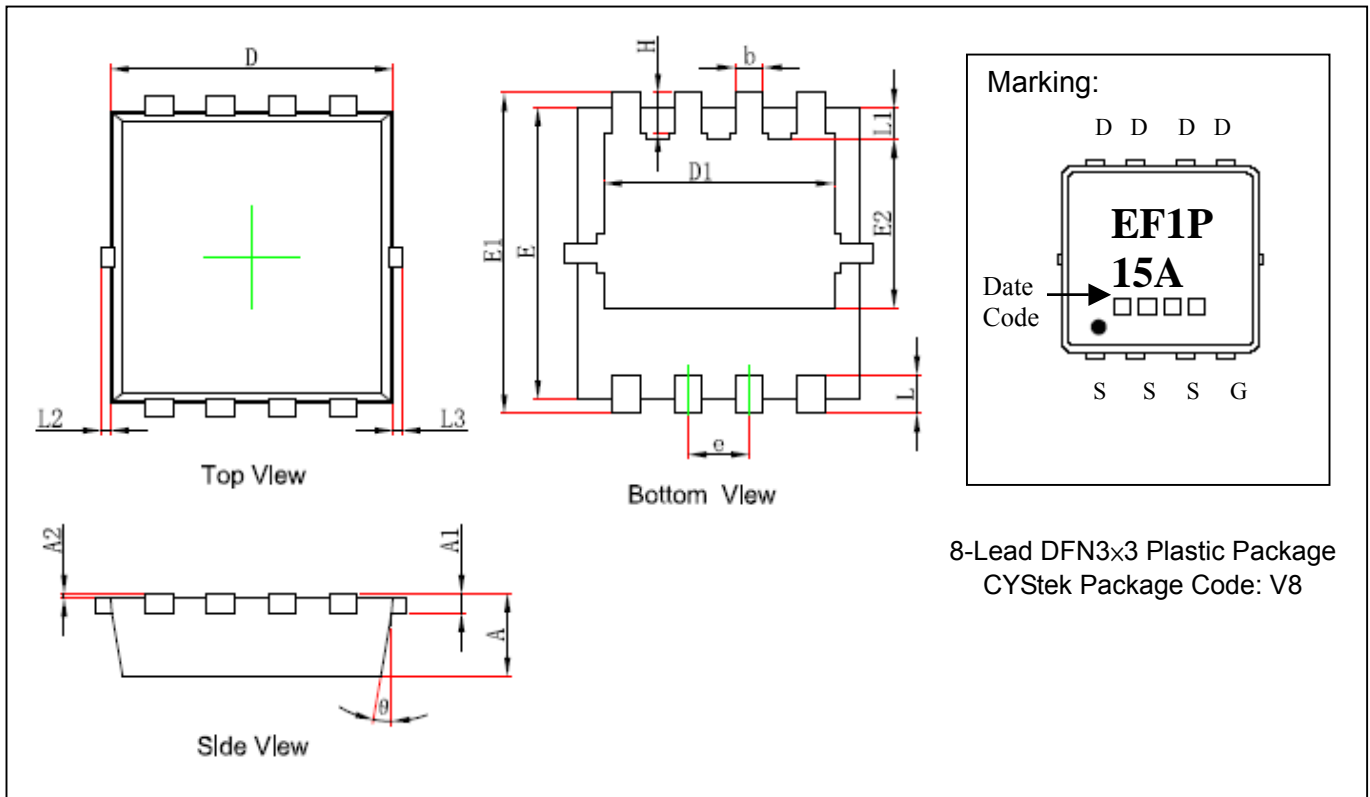

\*: Typical

DIM	Millimeters		Inches		DIM	Millimeters		Inches	
	Min.	Max.	Min.	Max.		Min.	Max.	Min.	Max.
A	0.605	0.850	0.026	0.033	b	0.200	0.400	0.008	0.016
A1	0.152	REF	0.006	REF	e	0.550	0.750	0.022	0.030
A2	0.000	0.050	0.000	0.002	L	0.300	0.500	0.012	0.020
D	2.900	3.100	0.114	0.122	L1	0.180	0.480	0.007	0.019
D1	2.300	2.600	0.091	0.102	L2	0.000	0.100	0.000	0.004
E	2.900	3.100	0.114	0.122	L3	0.000	0.100	0.000	0.004
E1	3.150	3.450	0.124	0.136	H	0.315	0.515	0.012	0.020
E2	1.535	1.935	0.060	0.076	θ	9°	13°	9°	13°

**Notes:** 1.Controlling dimension: millimeters.  
 2.Maximum lead thickness includes lead finish thickness, and minimum lead thickness is the minimum thickness of base material.  
 3.If there is any question with packing specification or packing method, please contact your local CYStek sales office.

**Material:**

- Lead: pure tin plated.
- Mold Compound: Epoxy resin family, flammability solid burning class: UL94V-0.

**Important Notice:**

- All rights are reserved. Reproduction in whole or in part is prohibited without the prior written approval of CYStek.
- CYStek reserves the right to make changes to its products without notice.
- CYStek **semiconductor products are not warranted to be suitable for use in Life-Support Applications, or systems.**
- CYStek assumes no liability for any consequence of customer product design, infringement of patents, or application assistance.